

Images for illustration purposes only

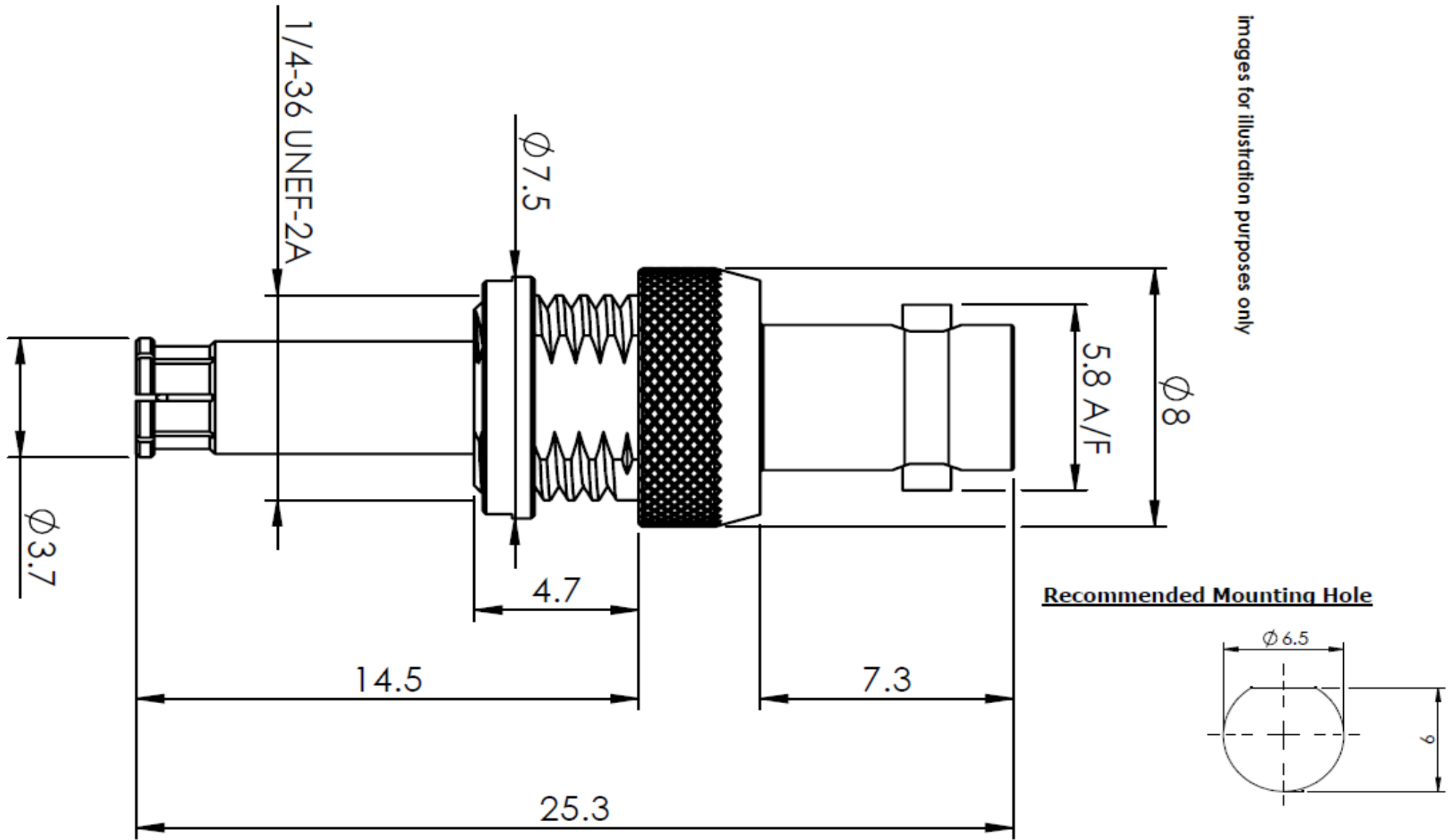

Part Number: 67-512-B66

COAX
CONNECTORS LTD