

images for illustration purposes only

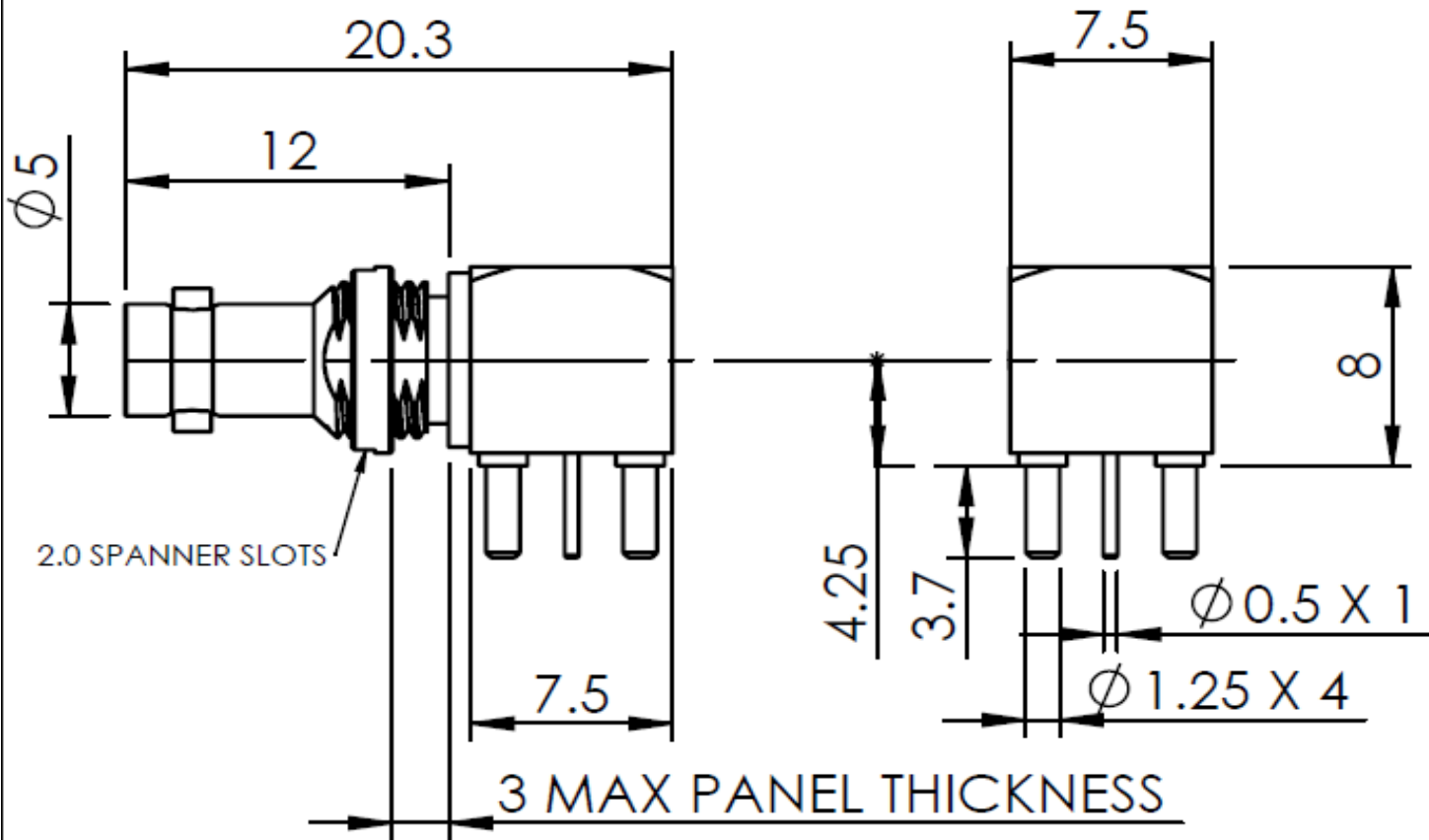

Recommended Mounting Hole

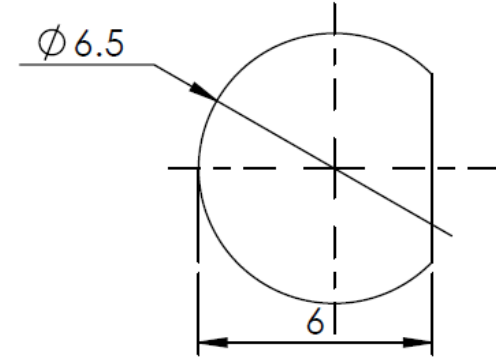

Recommended PCB Layout

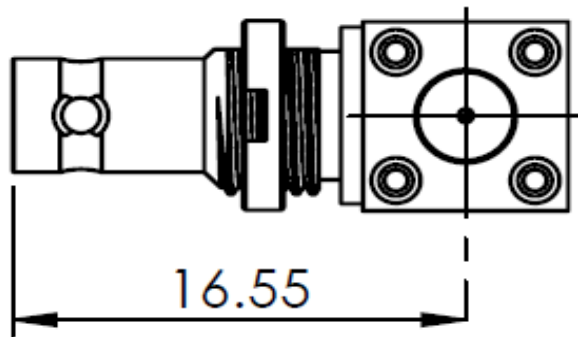
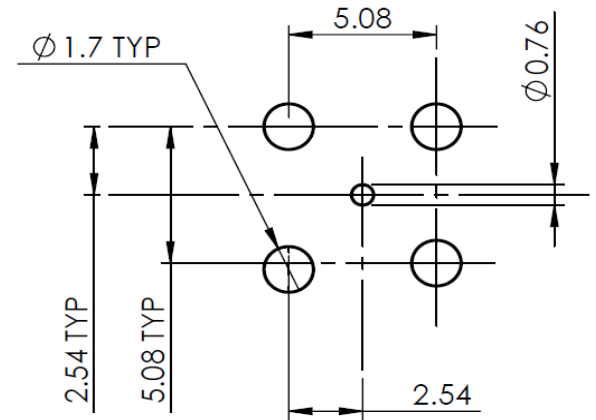

Part Number: 10-468-1-D66

COAX
CONNECTORS LTD