

Images for illustration purposes only

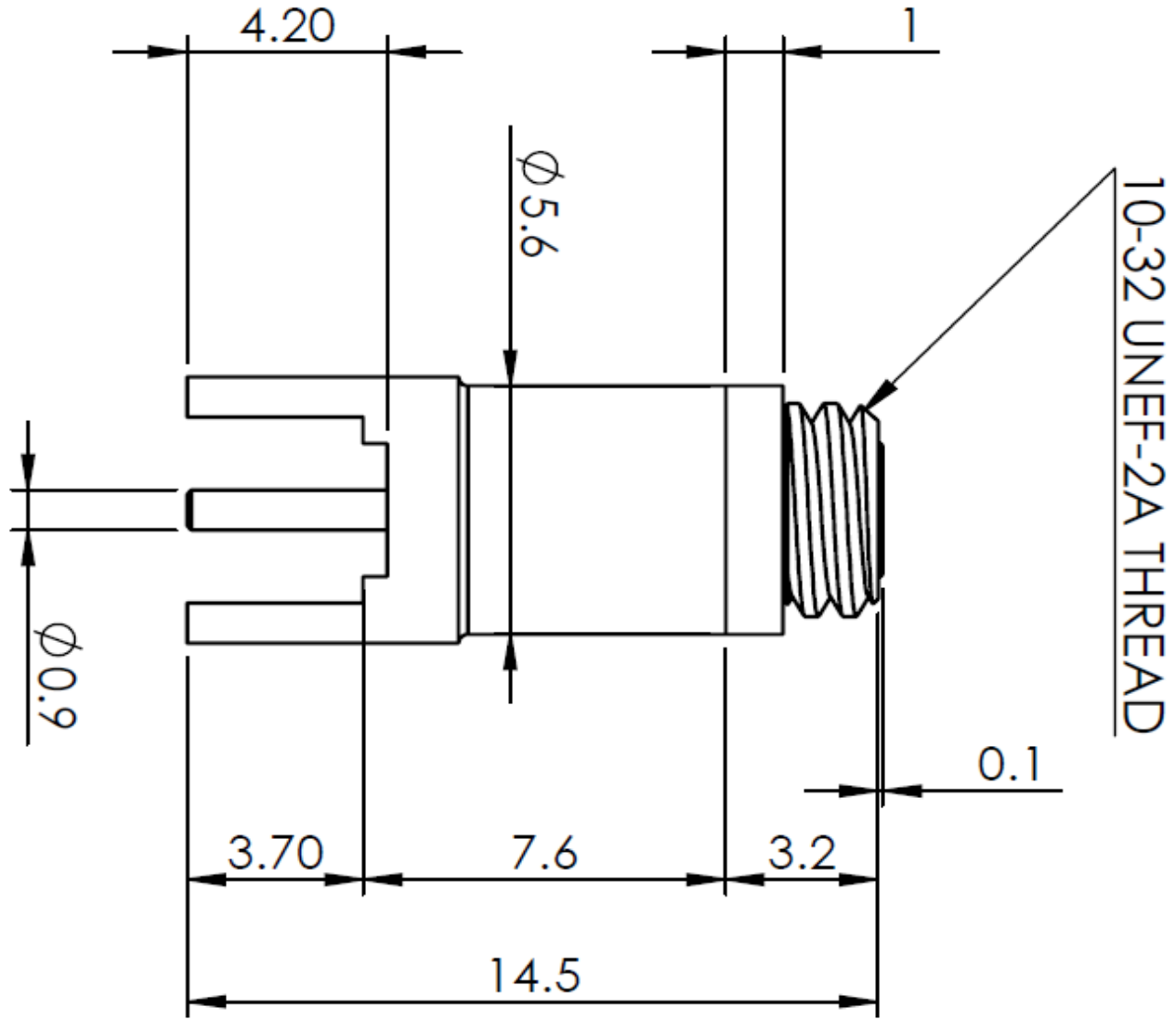

Recommended PCB Layout

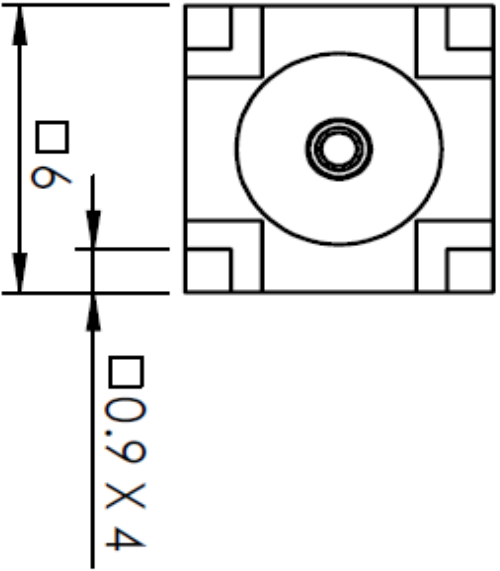
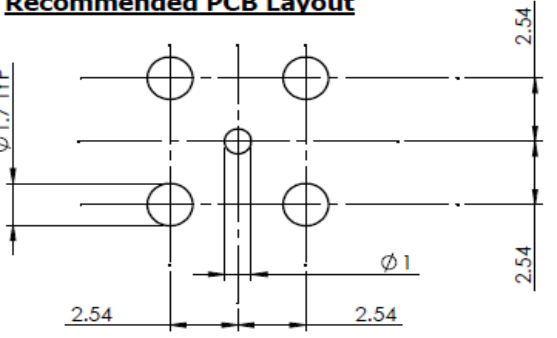

Part Number: 54-452-D3

