

images for illustration purposes only

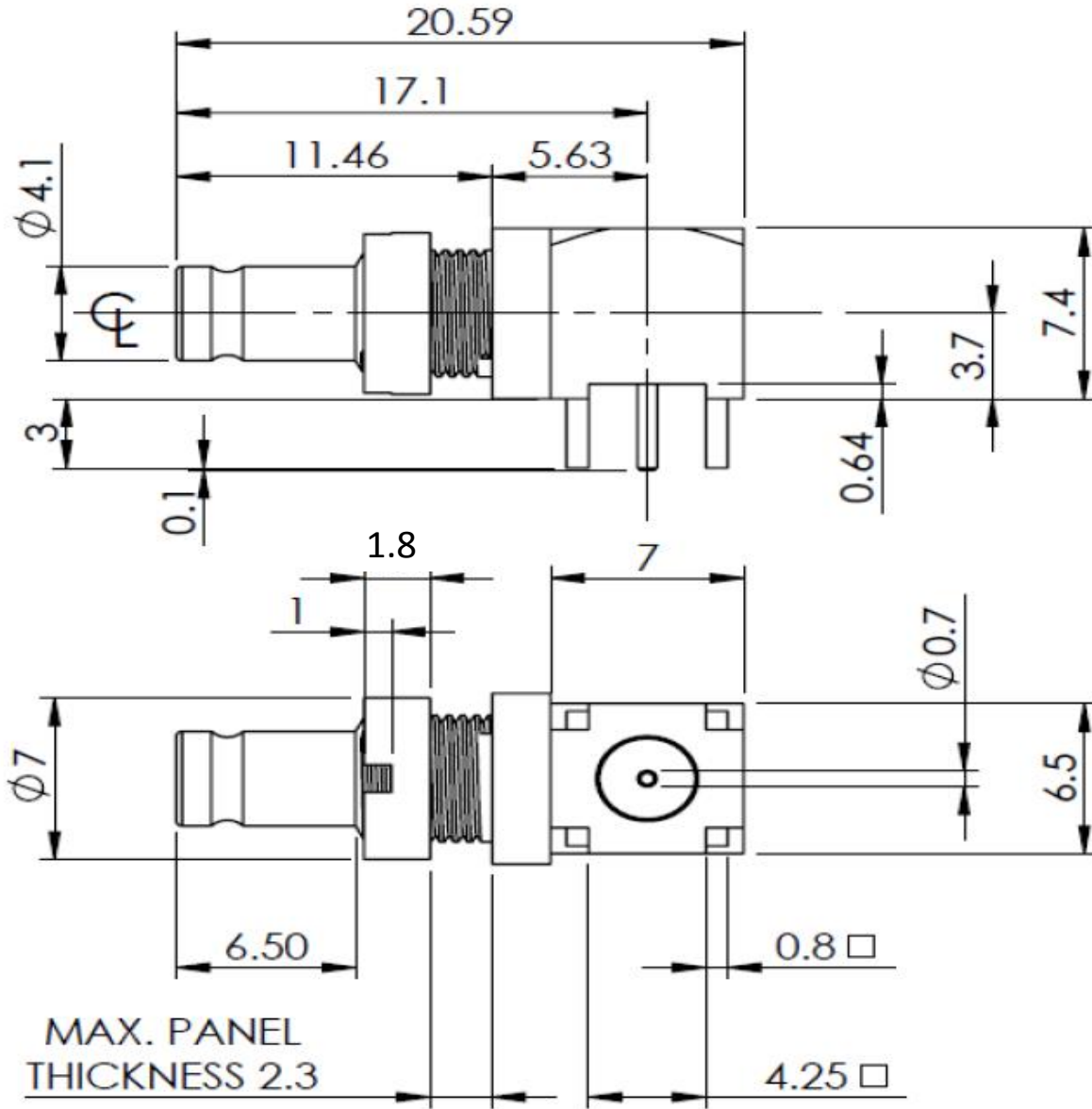

Recommended Mounting Hole

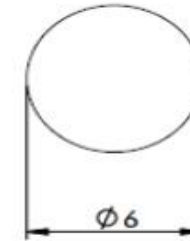

Recommended PCB Layout

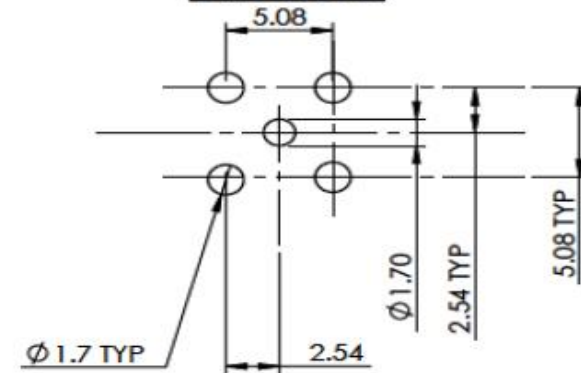

Part Number: 52-468-4-D36

COAX
CONNECTORS LTD