

Images for illustration purposes only

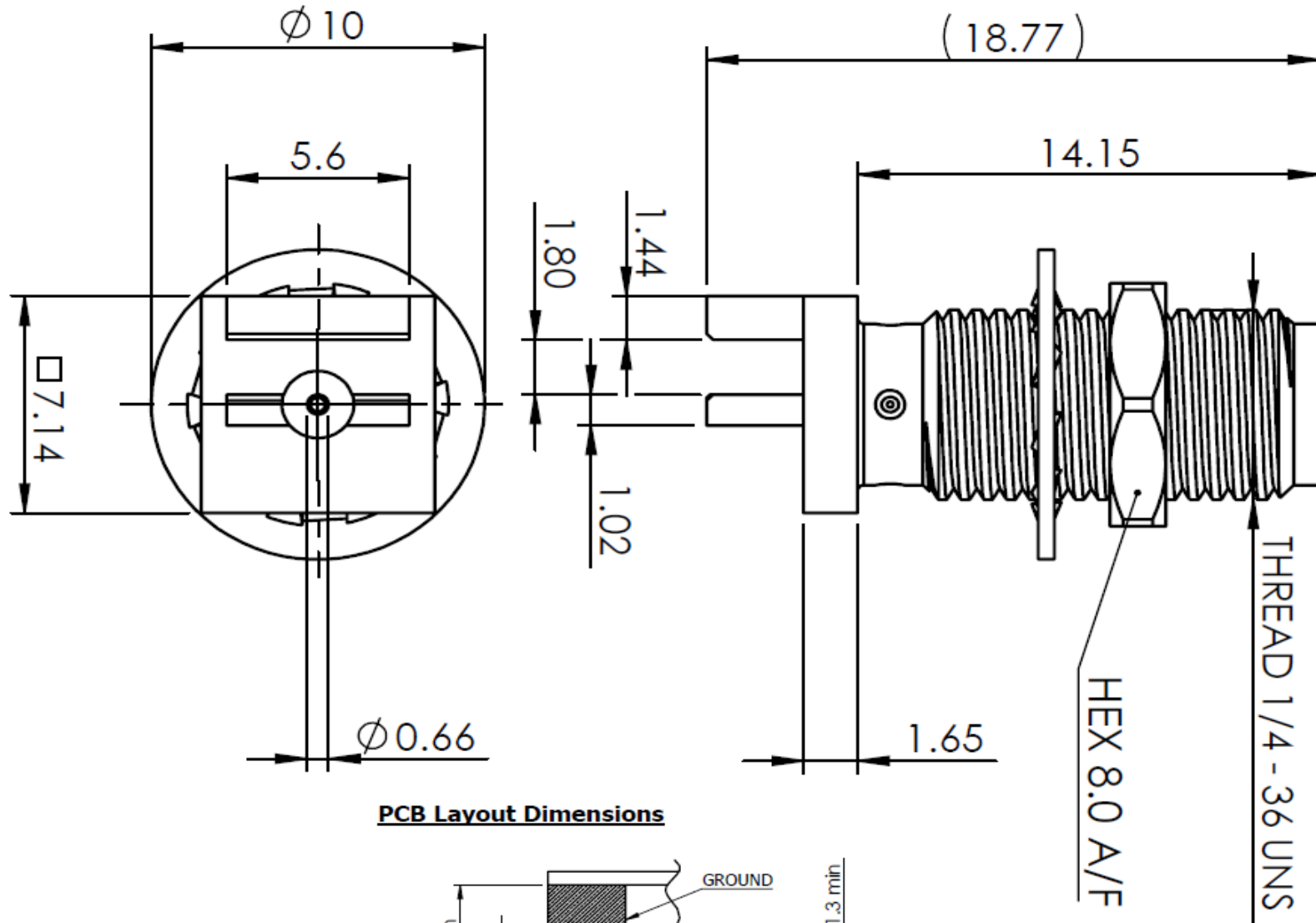

PCB Layout Dimensions

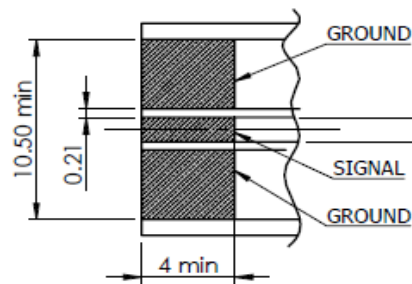

PCB MATERIAL:
GLASS EPOXY RESIN
(Er=4.8)
THICKNESS OF PCB:
1.70 MAX

COAX
CONNECTORS LTD

Part Number: 30-462-D3-1.8