

75 Ohm N TYPE BULKHEAD SOLDER CUP JACK (2 FLATS)

25-355-B6

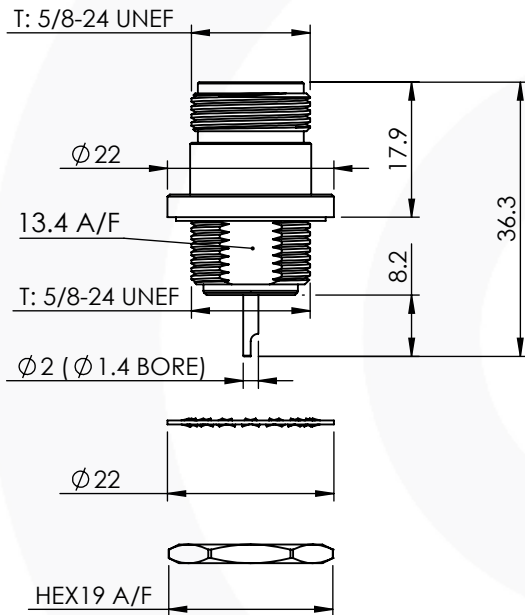

images for illustration purposes only



Recommended Mounting Hole

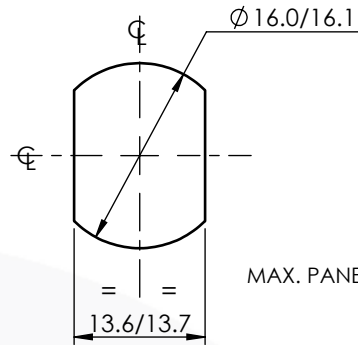

MAX. PANEL THICKNESS: 5mm

Tooling

Centre Contact: Not Applicable

Tool No: Solder

Crimp Sleeve: Not Applicable

Tool No: Not Applicable

Environmental Specification

Operating Temp: -55 to +155 Deg C.

IP Rating (Mated): IP 67

Electrical Specification

Impedance: 75 Ohm

Frequency: 0-2 GHz

Dielectric W/V: 2500 Veff

Insulation res: 5000 M-Ohm

Mechanical Specification

Contact Retention: 27 N min

Cable Retention: Not Applicable

Mating cycles: 500

Weight: 35.09 g

Connector Interface

image for illustration purposes only

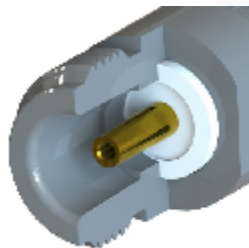

6	WASHER	STAINLESS STEEL	NICKEL
5	GASKET	SILICONE	N/A
4	NUT	BRASS	NICKEL
3	INSULATOR	PTFE	N/A
2	CENTRE CONTACT	PHOS. BRONZE	GOLD
1	BODY	BRASS	NICKEL
ITEM	DESCRIPTION	MATERIAL	PLATING

A4	SHEET 1 OF 1	DIMENSIONS ARE IN MILLIMETRES		
REVISION :	A00	NAME	SIGNATURE	DATE
ISSUE :	1	DRAWN	G.E.	11/04/20
		CHK'D	P.S.	11/04/20
		APPV'D		
6-8 COLNE ROAD, TWICKENHAM, MIDDLESEX. TW1 4JR				
THE INFORMATION IS GIVEN AS AN INDICATION ONLY AND IS SUBJECT TO CHANGE WITHOUT NOTICE. IN THE CONTINUAL GOAL TO IMPROVE OUR PRODUCTS, WE RESERVE THE RIGHT TO MAKE ANY MODIFICATIONS NECESSARY WITHOUT PRIOR NOTICE.				