

Recommended Mounting Hole

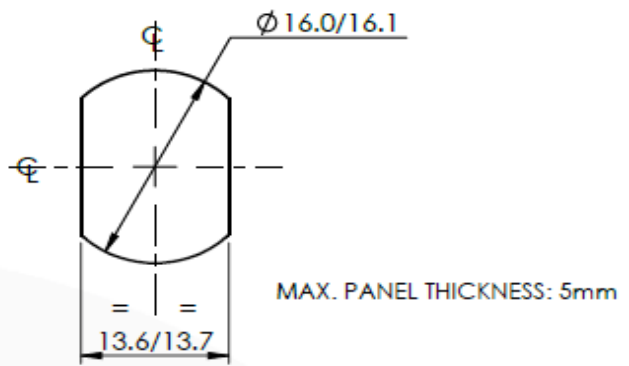

images for illustration purposes only

Part Number: 25-355-B3

