

Images for illustration purposes only

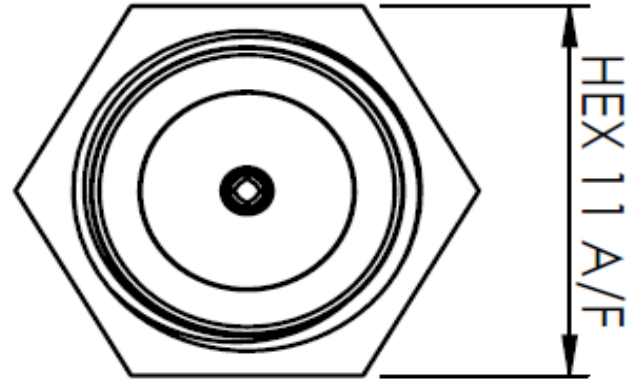
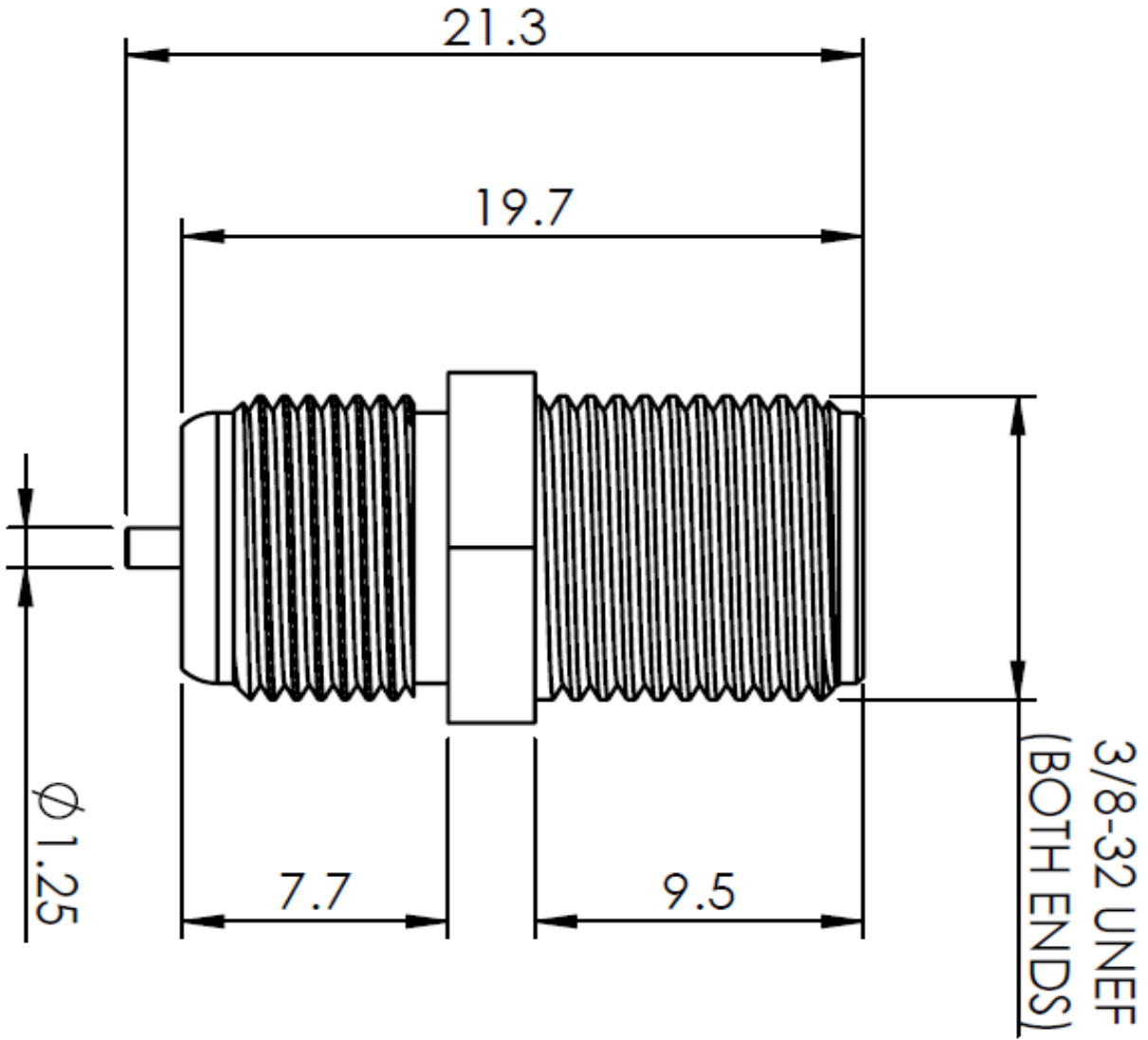

Part Number: 15-485-D6

COAX
CONNECTORS LTD